

# Independent V-8050

Con tappi inglobati nel vetro stratificato colorato  
 With not visible point fitting, for laminated coloured glass  
 Mit nicht sichtbaren Punkthaltern, für VSG lackiertes Glas

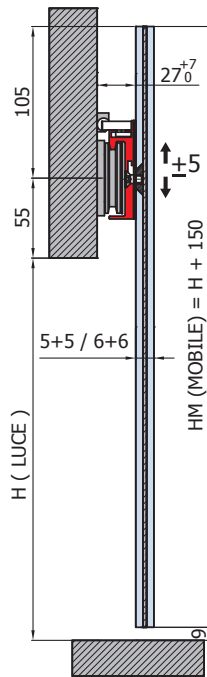

Lavorazione vetro  
 Glass preparation  
 Glasbearbeitung

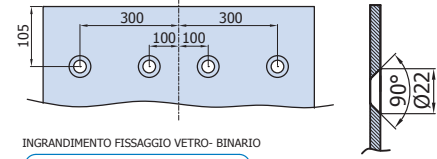

INGRANDIMENTO FISSAGGIO VETRO- BINARIO

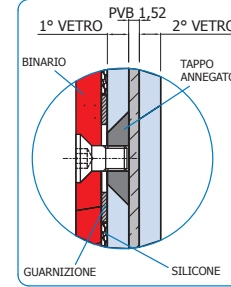

PARTICOLARE TAPPO INGLOBATO

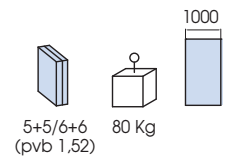
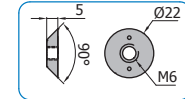

V-8050 set 1

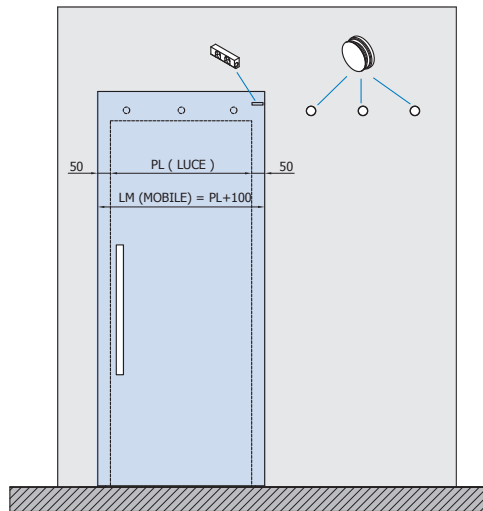

V-8050 set 2

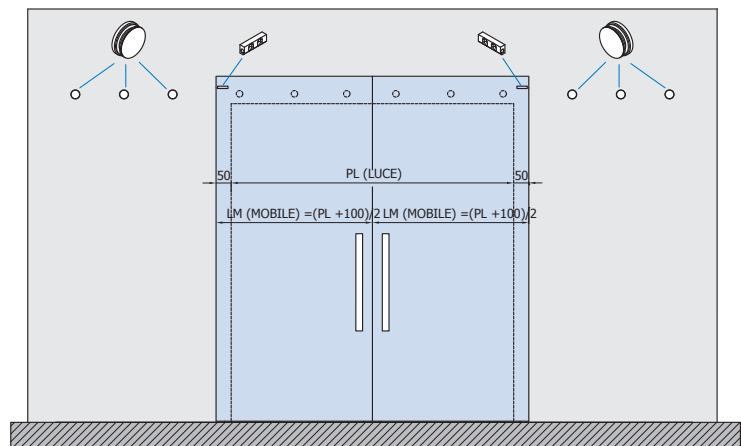

CR = Cromo lucido  
 Polished chrome  
 Chrom glänzend

Effetto inox  
 Inox effect  
 Inox effekt

PL = Passaggio luce - Clear opening width - Lichte Durchgangsbreite  
 LM = Larghezza anta mobile - Sliding door width - Schiebefügel Breite  
 HM = Altezza anta mobile - Sliding glass height - Schiebefügel Höhe  
 H = Altezza passaggio luce - Clear opening height - Lichte durchgangshöhe

xme 249e