

# Evolution Mini Soft-close V-5440

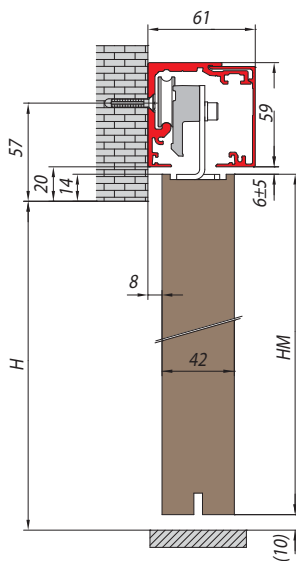

Per porte in legno  
For wooden doors  
Für Holztüren



$$HM = H + 14 - (10)$$

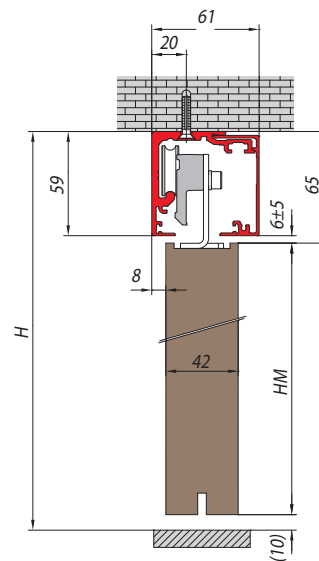

$$HM = H - 65 - (10)$$

V-5442

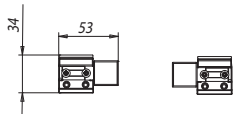
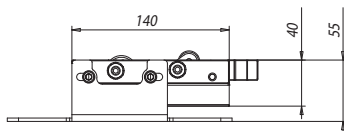
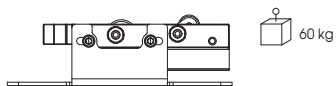

V-5446 Soft-close

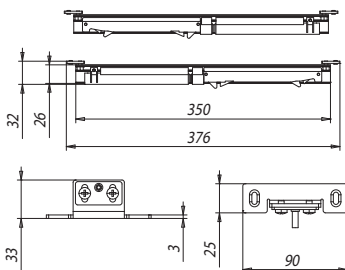

V-5307

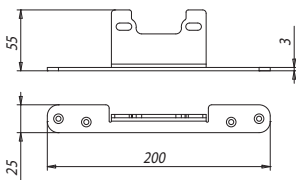

P-F08

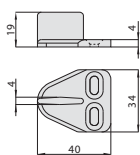

V-5400, V-5401

Altri componenti a pag. 10  
Other components at page 10  
Andere Einzelteile Seite 10

V-5440 set 1 Soft-close

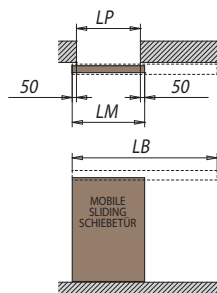

$$LB = LP \times 2 + 150$$

$$LM = LP + 100$$

V-5440 set 2 Soft-close

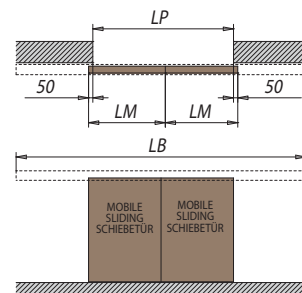

$$LB = LP \times 2 + 100$$

$$LM = (LP + 100) / 2$$

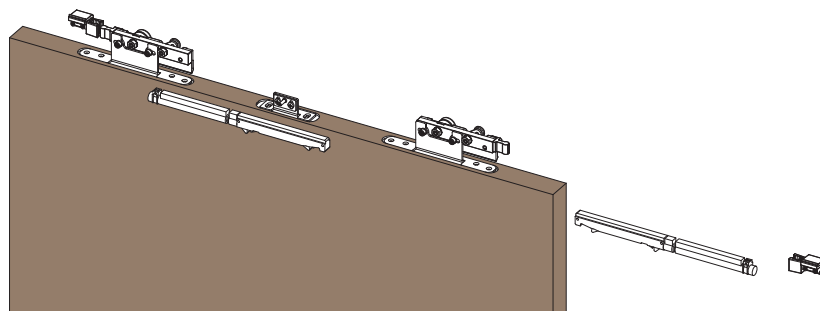

AN = Alluminio anodizzato  
Aluminium anodized  
Aluminium Silberfarbig

Effetto inox  
Inox effect  
Inox effekt

H = Altezza passaggio luce - Clear opening height - Lichte Höhe  
LP = Passaggio luce - Clear opening width - Lichte Breite  
HM = Altezza anta mobile - Sliding glass height - Schiebefügel Höhe  
LM = Larghezza vetro - Glass width - Glasbreite  
LB = Lunghezza binario - Rail length - Laufschiene Länge

xla355

